

**HERCULES  
ALUMINIUM  
SECURITY  
FENCING**

---

## ALUMINIUM PANELS

40 x 40 x 1.6mm SHS Rails  
 25 x 25 SHS Tube with  
 Crimped Spear Top  
 140mm Tube Centres

- 2400 x 1500mm Aluminium Panel
- 2400 x 1800mm Aluminium Panel
- 2400 x 2100mm Aluminium Panel

## PANEL FIXINGS

40 x 40mm Single Lug Fence Brackets

- 3 x 12-14\*20 Self Tapping Tek Screws used per Single Lug Fence Bracket

40 x 40mm Double Lug Fence Brackets Side Fit Security Bracket

- 5 x 12-14\*20 Self Tapping Tek Screws used per Double Lug Fence Bracket

## 65 x 65 x 2.5mm ALUMINIUM POSTS

In Ground Post Sizes:

- 2100mm; 2400mm; 2700mm, 3000mm; Per Metre

Aluminium Post + Base Plate Heights:

- 1300mm; 1600mm; 1900mm; 2200mm

### In Ground Post

200 x 500/600mm Post Hole filled with Post Mix Concrete

### Flanged Post - On Slab

M10 Stainless Steel Rod & Nut; Chemset Chemical Anchor

### Flanged Post - On Timber

M10 x 75mm Stainless Steel Batten Screw into structural timber

## SUBSTRATE

6063 T6 Aluminium

All of our Hercules Security Fencing are available in the Interpon Powder Coating Satin Black.

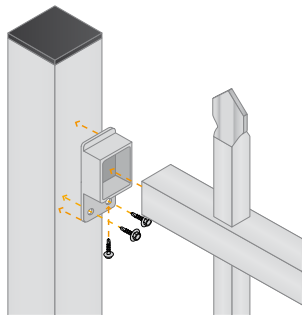

TOP BRACKET

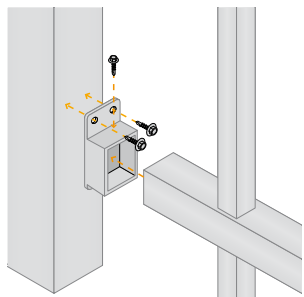

BOTTOM BRACKET

## SINGLE LUG BRACKET ASSEMBLY

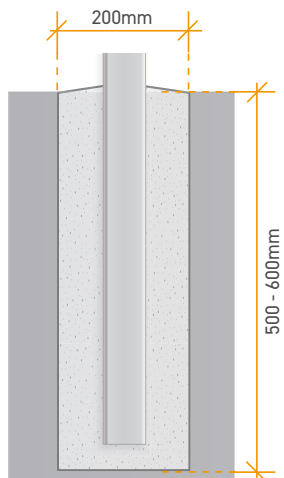
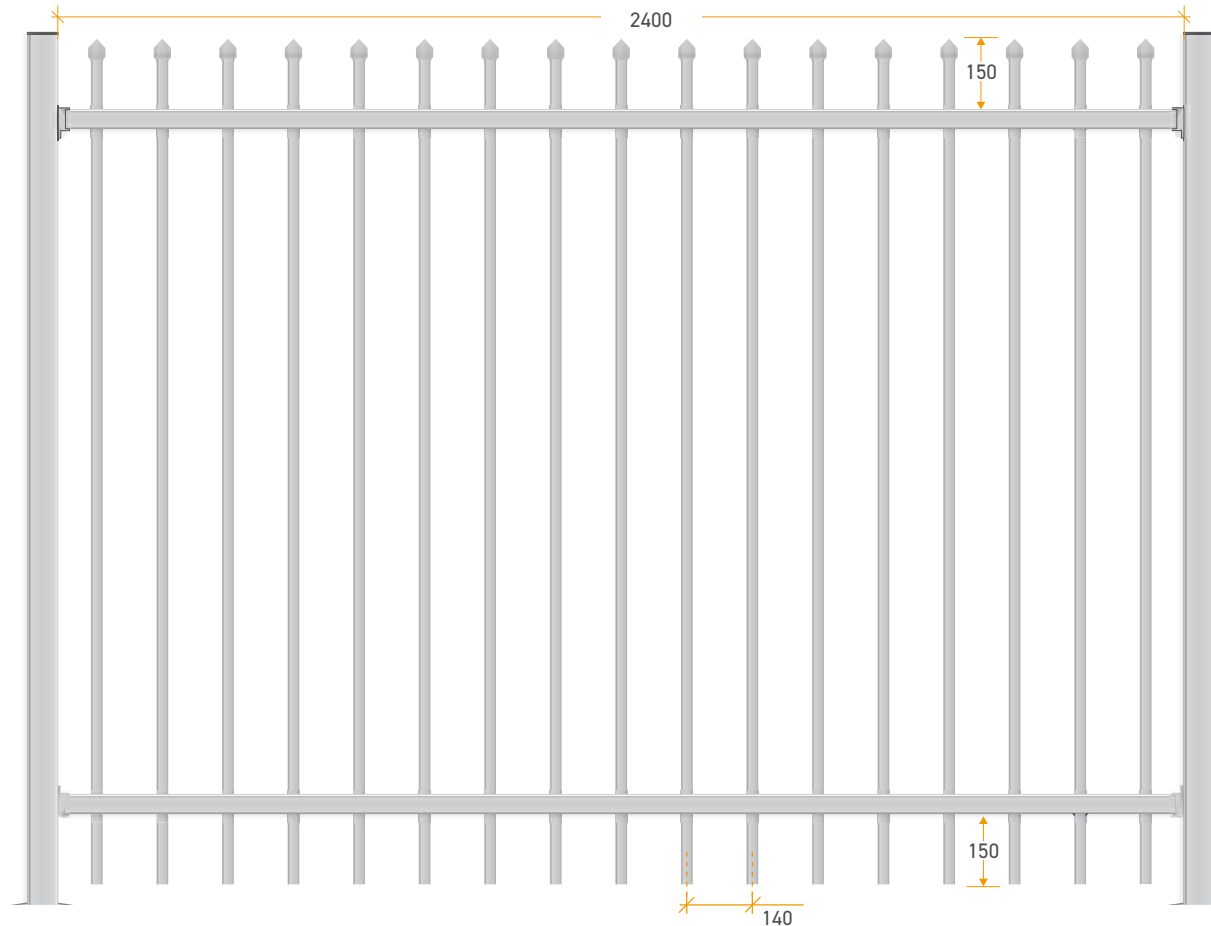

IN GROUND POST DETAIL

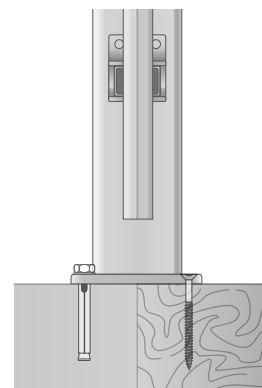

SLAB TIMBER

FLANGED (ON SLAB/TIMBER) POST DETAIL

**BASE PLATE**  
 100 x 135mm  
 11mm HOLES  
 REFER TO NOTES

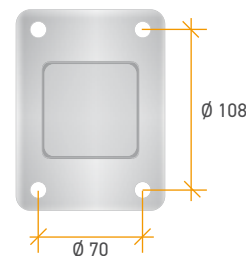

CRIMPED SPEAR TOP DETAIL

TITLE: **ALUMINIUM HERCULES SECURITY FENCING**

CONTACT: [sales@oxworks.com.au](mailto:sales@oxworks.com.au)

[oxworks.com.au](http://oxworks.com.au) 1300 336 237

**HERCULES  
STEEL  
SECURITY  
FENCING**



## STEEL PANELS

40 x 40 x 1.6mm SHS Rails

25 x 25 SHS Tube with  
Crimped Spear Top

140mm Tube Centres

- 2400 x 1500mm Steel Panel
- 2400 x 1800mm Steel Panel
- 2400 x 2100mm Steel Panel
- 2100 x 2400mm Steel Panel

## PANEL FIXINGS

40 x 40mm Single Lug Fence Brackets

- 3 x 12-14\*20 Self Tapping Tek Screws used per Single Lug Fence Bracket

40 x 40mm Double Lug Fence Brackets Side Fit Security Bracket

- 5 x 12-14\*20 Self Tapping Tek Screws used per Double Lug Fence Bracket

## 65 x 65 x 2.5mm STEEL POSTS

In Ground Post Sizes:

- 2100mm; 2400mm; 2700mm, 3000mm; Per Metre

Steel Post + Base Plate Heights:

- 1300mm; 1600mm; 1900mm; 2200mm; 2500mm

- **In Ground Post**  
200 x 500/600mm Post Hole filled with Post Mix Concrete
- **Flanged Post - On Slab**  
M10 Stainless Steel Rod & Nut; Chemset Chemical Anchor
- **Flanged Post - On Timber**  
M10 x 75mm Stainless Steel Batten Screw into structural timber

## SUBSTRATE

Galvanised Steel

All of our Hercules Security Fencing are available in the Interpon Powder Coating Satin Black.

Hercules Steel panels, gates and posts are zinc primed prior to powder coating

TITLE: **STEEL HERCULES SECURITY FENCING**

CONTACT: [sales@oxworks.com.au](mailto:sales@oxworks.com.au)

[oxworks.com.au](http://oxworks.com.au) 📞 1300 336 237

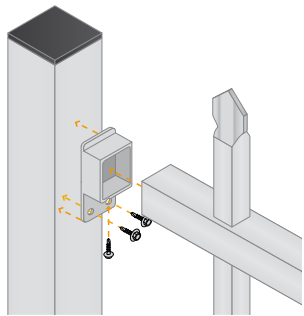

TOP BRACKET

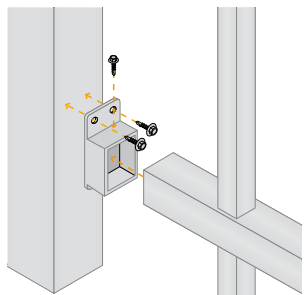

BOTTOM BRACKET

## SINGLE LUG BRACKET ASSEMBLY

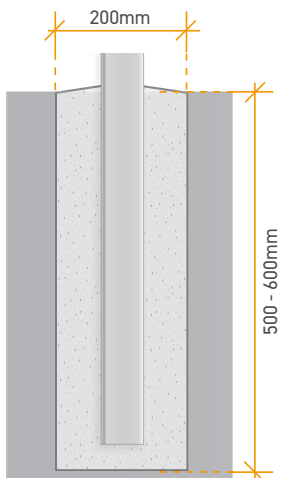
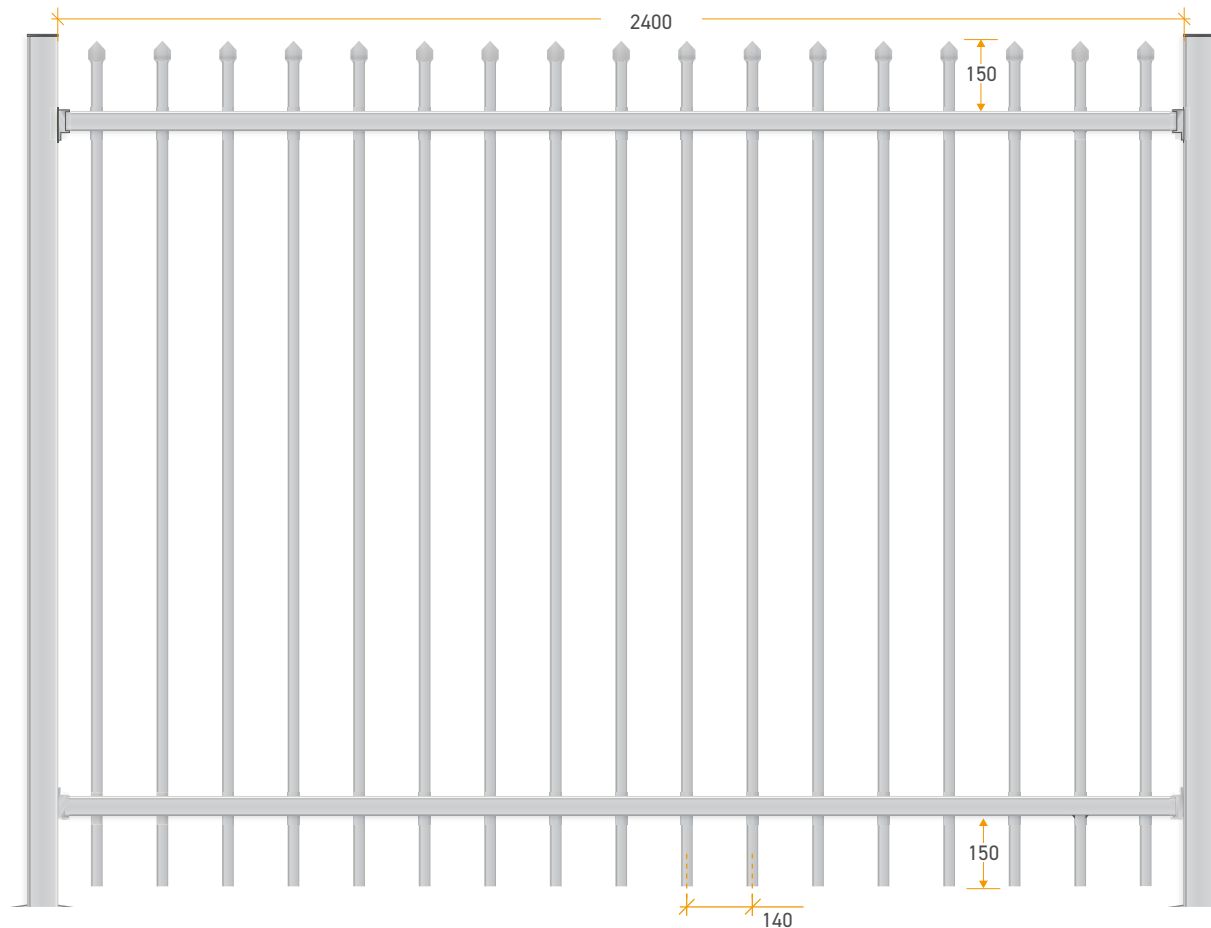

IN GROUND POST DETAIL

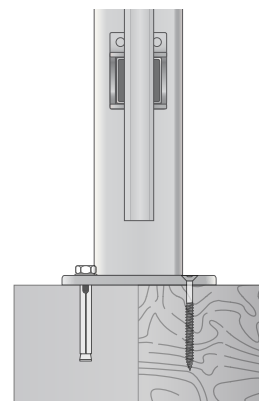

FLANGED (ON SLAB/TIMBER) POST DETAIL

**BASE PLATE**  
150 x 150mm  
14mm HOLES  
REFER TO NOTES

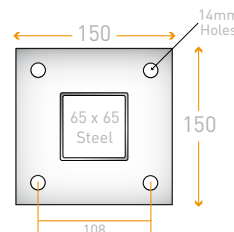

CRIMPED SPEAR TOP DETAIL

## WELDS & PRIMING

Hercules Steel panels and gates use Silicon Bronze Welds and are Zinc primed prior to powder coating



## STEEL D.E.T. SPEC PANELS - QLD ONLY

(HE2400BL)

40 x 40 x 2mm SHS Rails  
 25 x 25 x 1.6mm SHS Tube with  
 Crimped Spear Top  
 125mm Tube Centres

- 2400 x 2100mm Steel Panel

### PANEL FIXINGS

40 x 40mm Double Lug Fence Brackets Side Fit Security Bracket

- 5 x 12-14\*20 Anti Tamper Self Tapping Tek Screws used per Double Lug Fence Bracket
- Side Fit Security Brackets allow up to 15 Degrees of vertical rake

### 75 x 75 x 3mm STEEL POSTS

In Ground Post Sizes:

- 3000mm (SP7530BL); Per Metre

- **In Ground Post**

200 x 500/600mm Post Hole filled with Post Mix Concrete

- **Core Drilled Post**

Minimum 120mm x 150mm Core Drill Hole filled with MP60 Non-Shrink Bostik Grout

### 100 x 100 x 4mm STEEL POSTS

In Ground Post Sizes:

- 3000mm (HE1030BL); Per Metre

- **In Ground Post**

200 x 500/600mm Post Hole filled with Post Mix Concrete

### SUBSTRATE

Galvanised Steel

All of our Hercules Security Fencing are available in the Interpon Powder Coating Satin Black.

Hercules DETE panels, gates and posts are zinc primed prior to powder coating

TITLE: **STEEL D.E.T.E. HERCULES SECURITY FENCING**

CONTACT: [sales@oxworks.com.au](mailto:sales@oxworks.com.au)

[oxworks.com.au](http://oxworks.com.au) 1300 336 237

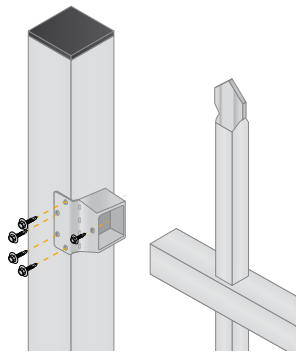
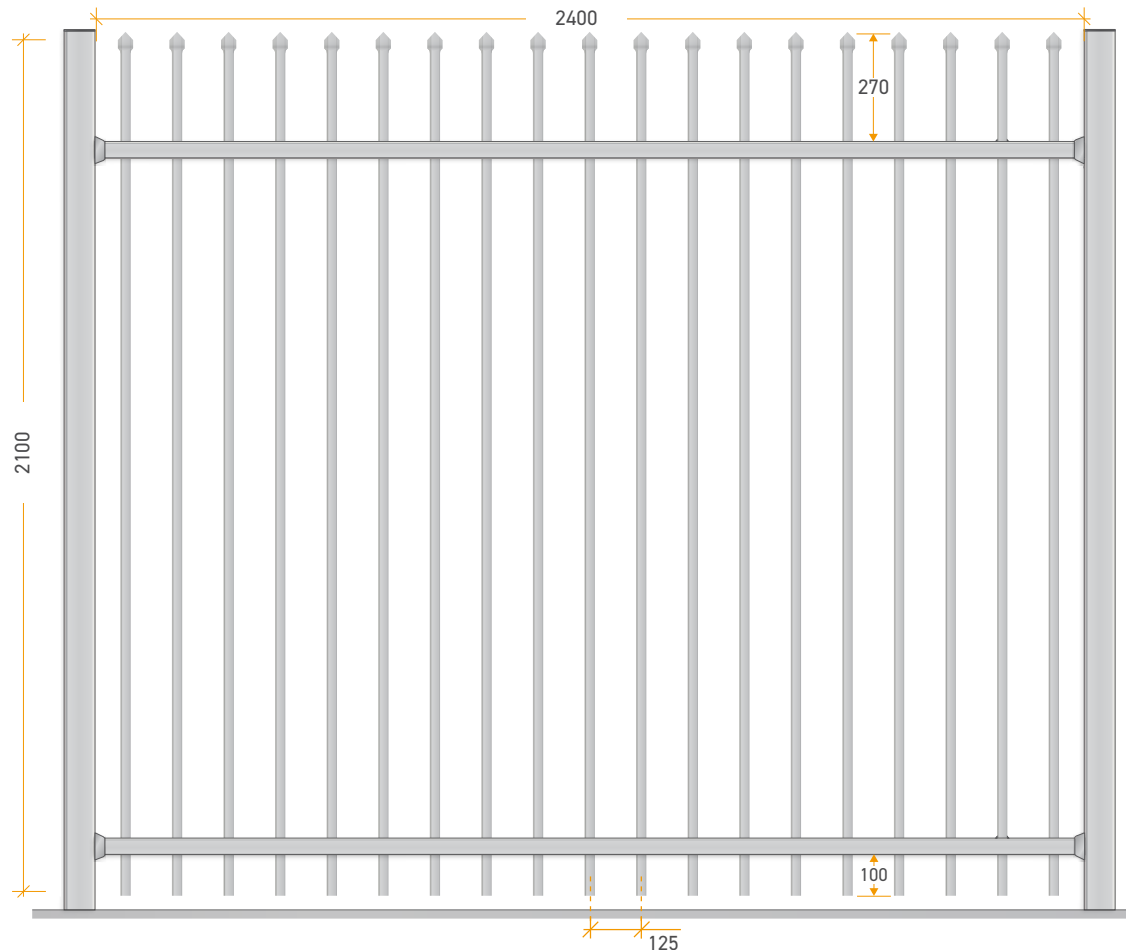

TOP BRACKET

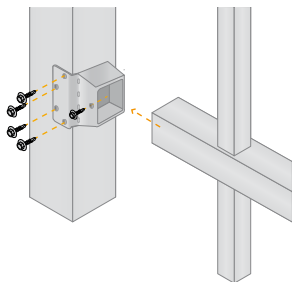

BOTTOM BRACKET

### SIDE FIT SECURITY BRACKET ASSEMBLY

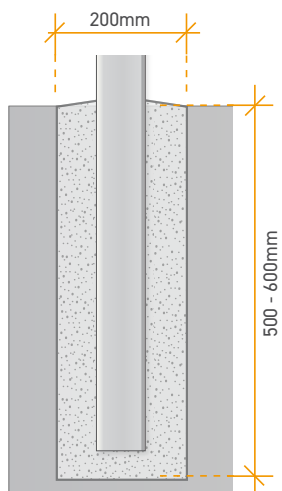

IN GROUND POST DETAIL

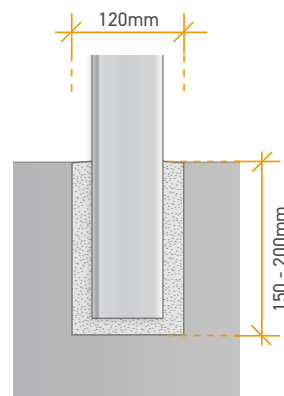

CORE DRILLED POST DETAIL



CRIMPED SPEAR TOP DETAIL

### WELDS & PRIMING

Hercules Steel panels and gates use Silicon Bronze Welds and are Zinc primed prior to powder coating



## STEEL SCHOOL SPEC PANELS - WA ONLY

### 2400mm x 2100mm Panels

- 40 x 40 x 3mm SHS Rails
- 25 x 25 x 1.6mm SHS Tube with Crimped Spear Top
- 127mm Tube Centres
- Face Welded Spear Tubes
- Min 18 Spears per Panel

### PANEL FIXINGS

- 40 x 40mm Side Fit Security Bracket
- 6 x 12-14\*20 Anti Tamper Self Tapping Tek Screws used per Double Lug Fence Bracket

### STEEL POSTS

- Intermediate Posts:**  
65 x 65 x 3mm @ 3000mm
- End Corner Posts:**  
100 x 100 x 3mm @ 3000mm
- **In Ground Post Fixing**  
200-300 x 800-900mm Post Hole filled with Post Mix Concrete
- **Core Drilled Post Fixing**  
Minimum 120/180mm x 500-600mm Core Drill Hole filled with MP60 Non-Shrink Bostik Grout
- Post Caps - P/Coated Galvanised Steel

### SUBSTRATE

Australian Sourced Galvanised Steel - Internal and External

All of our Hercules Security Fencing are coated using Interpon Powder Coating Satin Black.



TITLE: **STEEL HERCULES**  
WA SCHOOL SPEC FENCING

CONTACT: [sales@oxworks.com.au](mailto:sales@oxworks.com.au)

[oxworks.com.au](http://oxworks.com.au) 1300 336 237

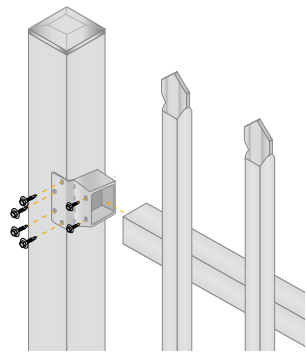

TOP BRACKET

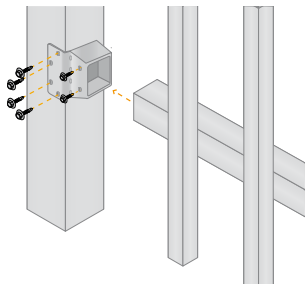

BOTTOM BRACKET

### SIDE FIT SECURITY BRACKET ASSEMBLY

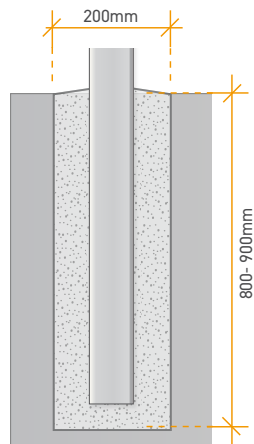
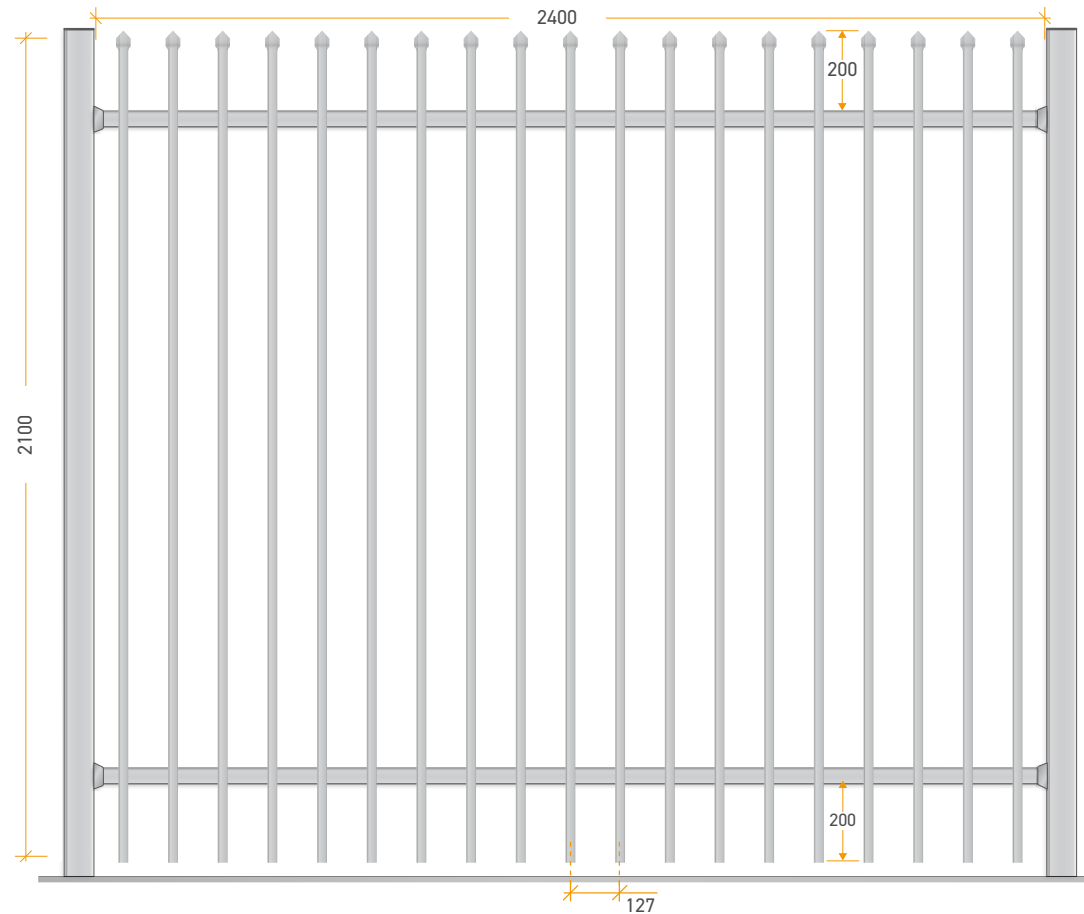

65 x 65 In Ground

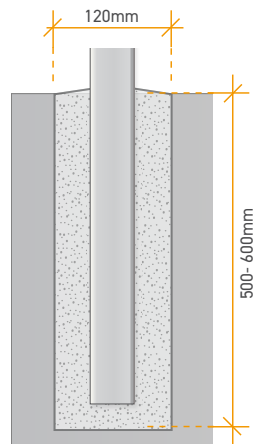

65 x 65 Core Drilled

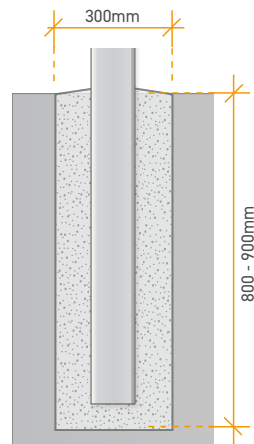

100 x 100 In Ground

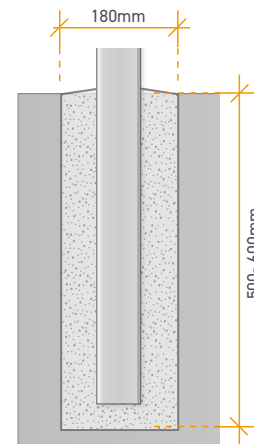

100 x 100 Core Drilled



CRIMPED  
SPEAR TOP DETAIL